

FWB2503-J

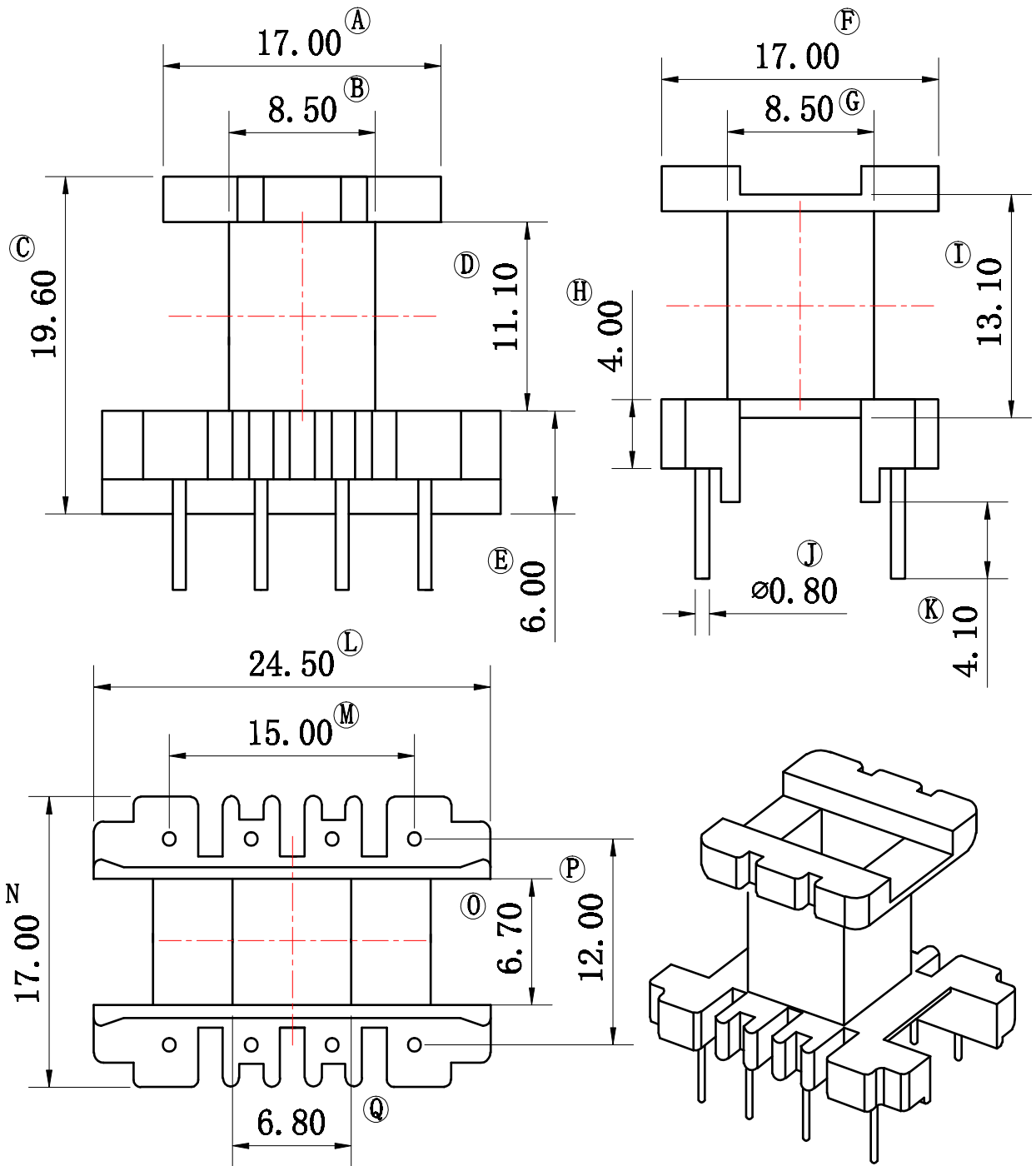

REV	REVISION RECORD	DATE	REV	REVISION RECORD	DATE
A			C		
B			D		

NAME	EE25 4+4P	MATERIAL	PHENOLIC	SCALE	ANGLE	$\pm 1^\circ$
DRAWING NO.	FWB2503-J	PIN MATERIAL	CP WIRE	UNIT	m/m	REV
TOLERANCE OF PIN PITCH	± 0.20		HAINING FERRIWO ELECTRONICS CO.,LTD.			
PIN TENSION LOAD	kg MN	UL REC: 94V-0	TEL: +86-573-87088701 FAX: +86-573-87081130			
TOLERANCE:	0<L≤4: ±0.2	4<L≤16: ±0.3	16<L≤63: ±0.4	Web: www.ferriwo.com Email: sales@ferriwo.com		